

ASSEMBLY INSTRUCTION

PLEASE READ BEFORE ASSEMBLING!

Tip #1: Make sure you've taken all the pieces and hardware out of its packaging before discarding the box.

Tip #2: Using page 2 and/or page 3 of instruction manual make sure all pieces and hardware are accounted for.

Tip #3: Read manual before assembling, it helps!

ITEM#: 14852

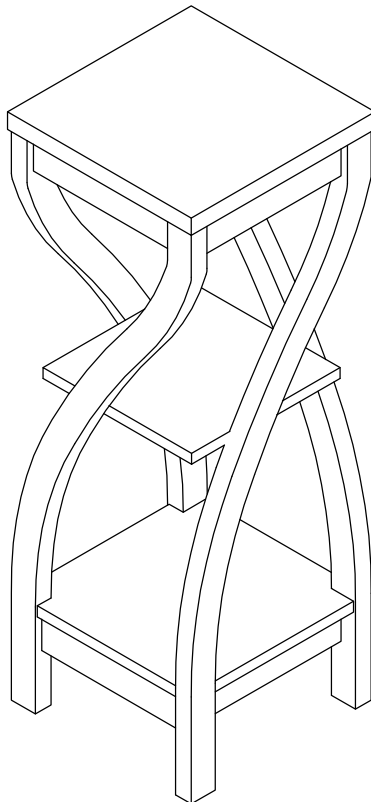

PARTS IDENTIFICATION



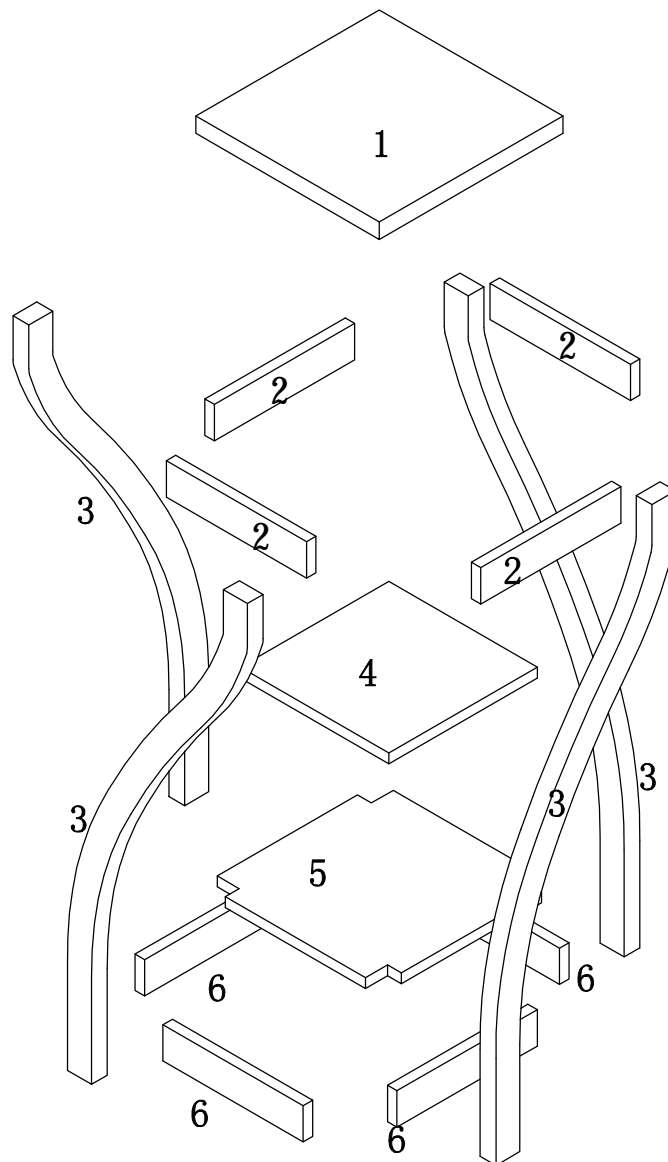

ITEM#: 14852

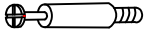

(1)	1pc
(2)	4pcs
(3)	4pcs
(4)	1pc
(5)	1pc
(6)	4pcs

HARDWARE IDENTIFICATION

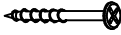
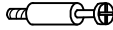
ITEM#: 14852

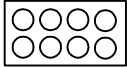
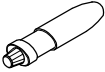
A		L29	16pcs
B		Ø15	16pcs
C		Ø8x25	8pcs
D		Ø4. 2x60	4pcs
E		L23	16pcs
F		Ø12	16pcs
G		Ø13	4pcs
H		Glue: For securing please apply to wood dowel first before inserting into panel	1pc

ASSEMBLY INSTRUCTION

ITEM#: 14852

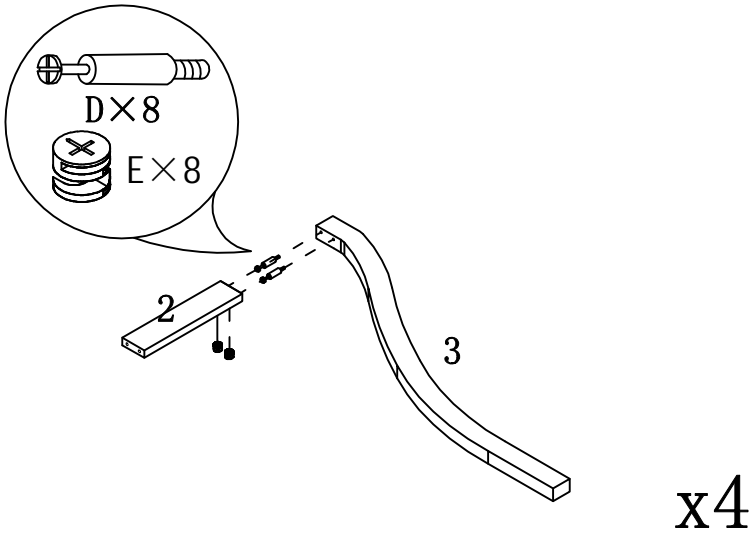

STEP 1

STEP 2

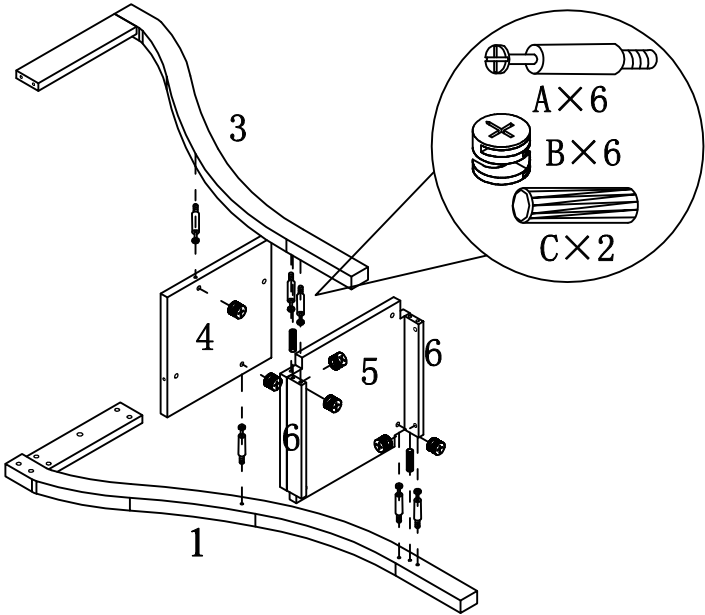

ASSEMBLY INSTRUCTION

ITEM#: 14852

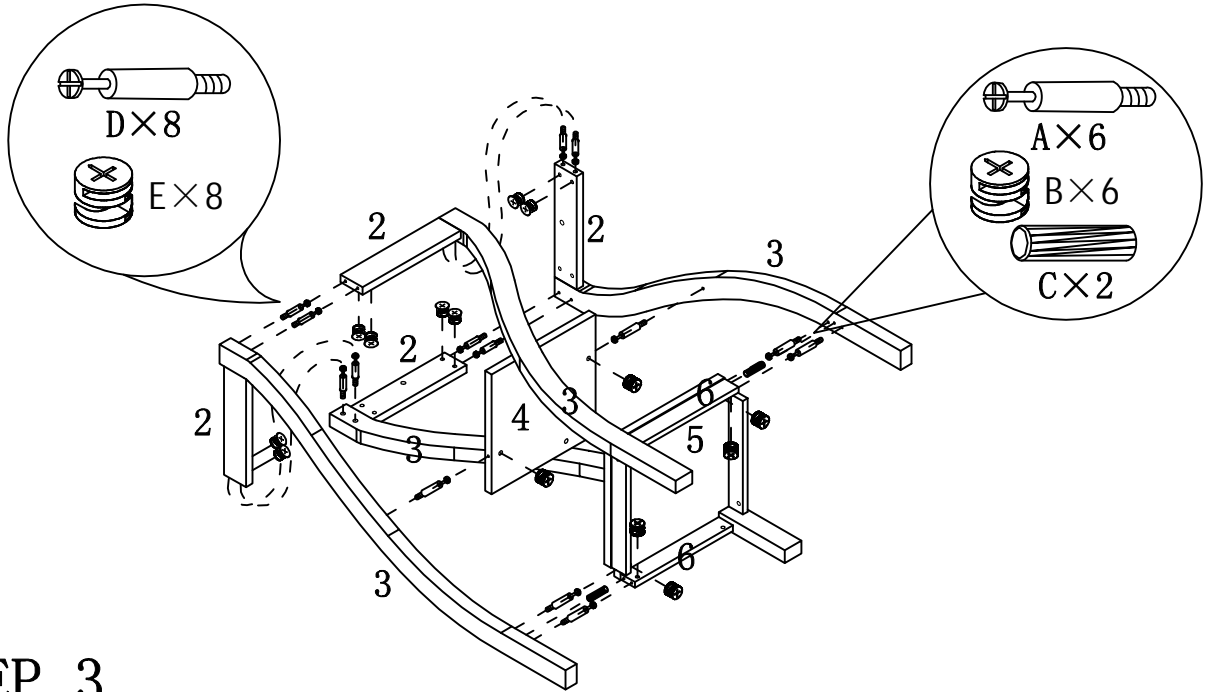

STEP 4

