

# ASSEMBLY INSTRUCTION

---

## PLEASE READ BEFORE ASSEMBLING!

Tip #1: Make sure you've taken all the pieces and hardware out of its packaging before discarding the box.

Tip #2: Using page 2 and/or page 3 of instruction manual make sure all pieces and hardware are accounted for.

Tip #3: Read manual before assembling, it helps!

ITEM#: 151032CT 172255CT

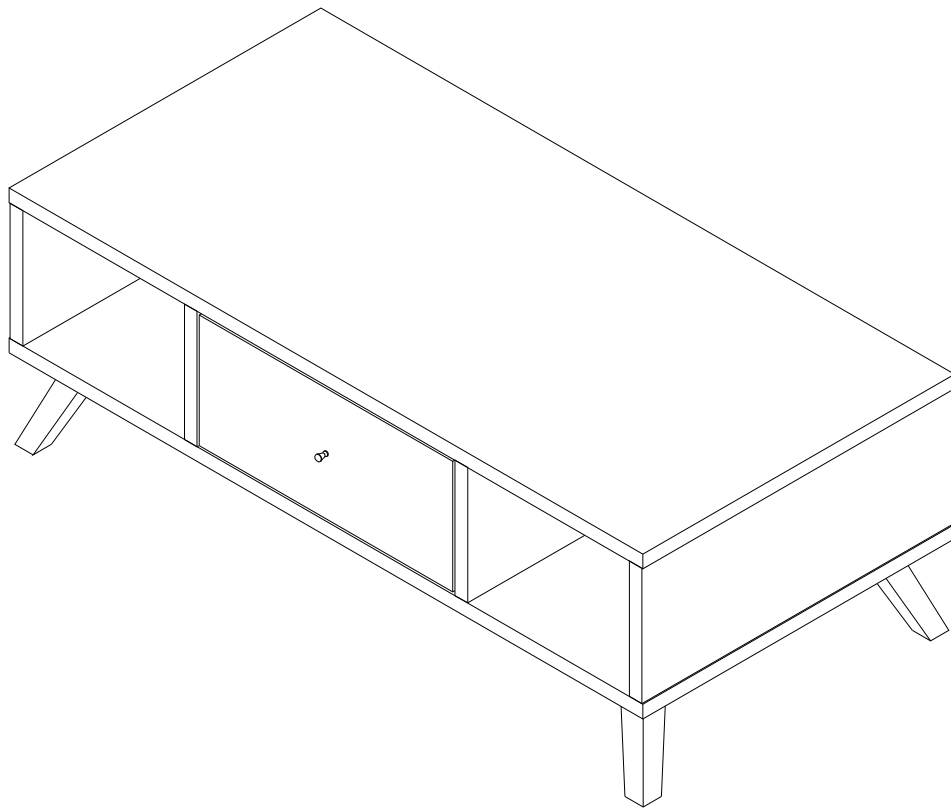

# PARTS IDENTIFICATION



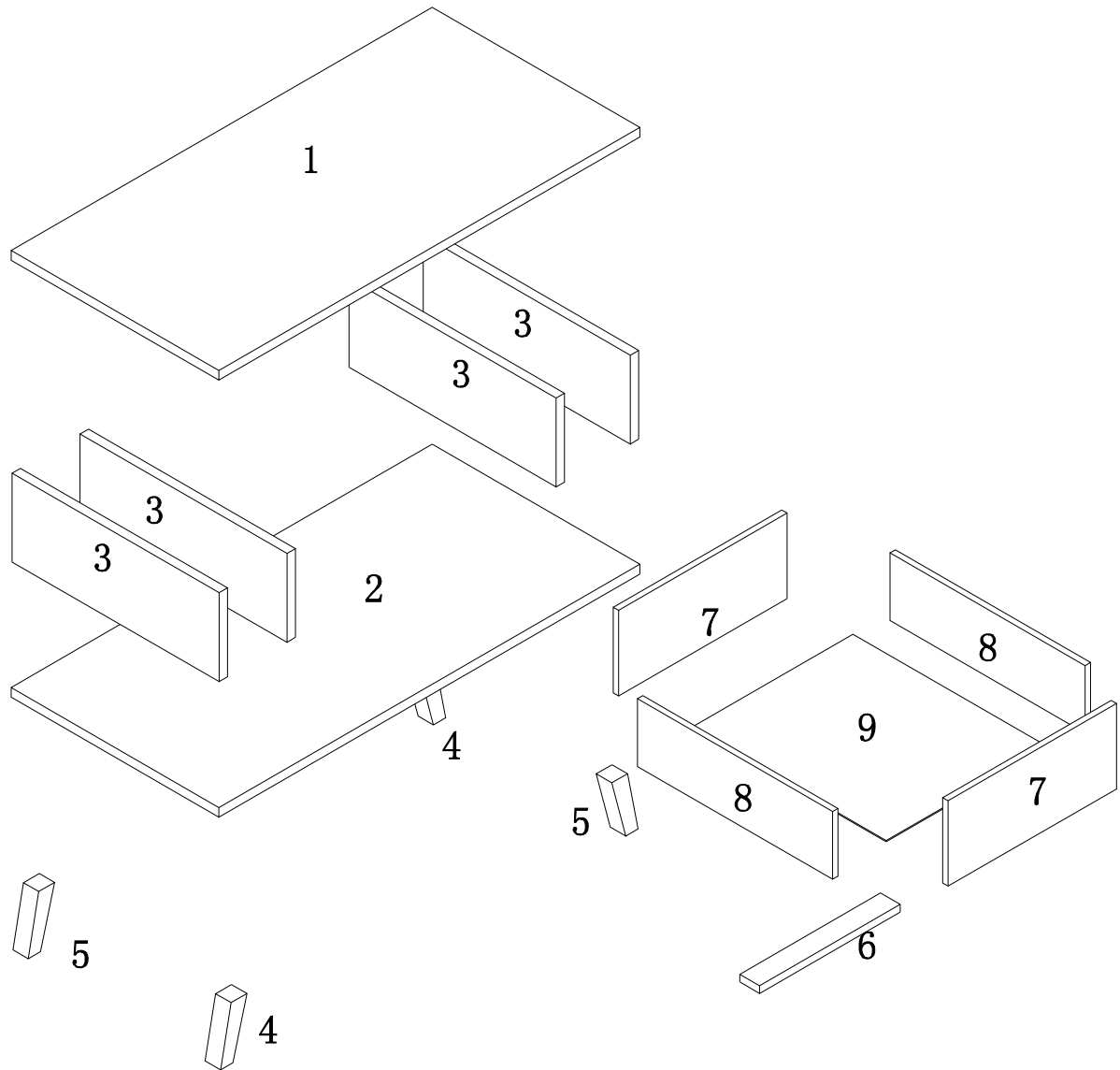







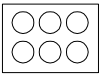
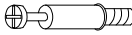

ITEM#: 151032CT

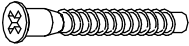

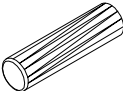
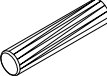
(1)	1pc	(6)	1pc
(2)	2pcs	(7)	2pcs
(3)	4pcs	(8)	2pc
(4)	2pcs	(9)	1pc
(5)	2pc		

# HARDWARE IDENTIFICATION

ITEM#: 151032CT

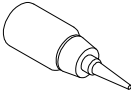
A		L29	8pcs
B		Φ 15	8pcs
C		Φ 20	12pcs
D		L20	8pcs
E		Φ 12	8pcs
F		Φ 7x48	8pcs
G		Φ 16x2	12pcs
H		Φ 8x25	12pcs
I		Φ 6x30	4pcs
J		80x25x150	1pcs
K		Φ 4x16	2pcs
L			2pcs
M		M4x22	2pcs
N		M8x35	4pcs
O		M5	1pc
P		Glue: For securing please apply to wood dowel first before inserting into panel	1pc

# ASSEMBLY INSTRUCTION

ITEM#: 151032CT

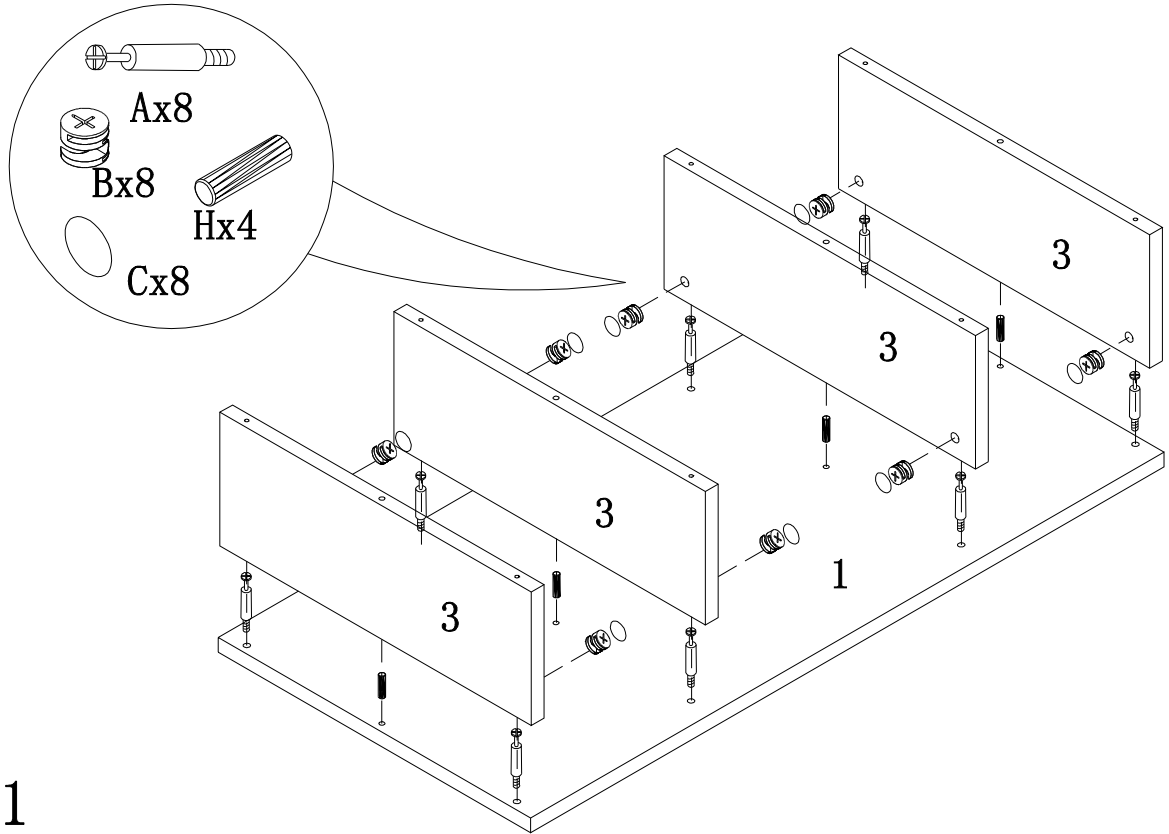

STEP 2

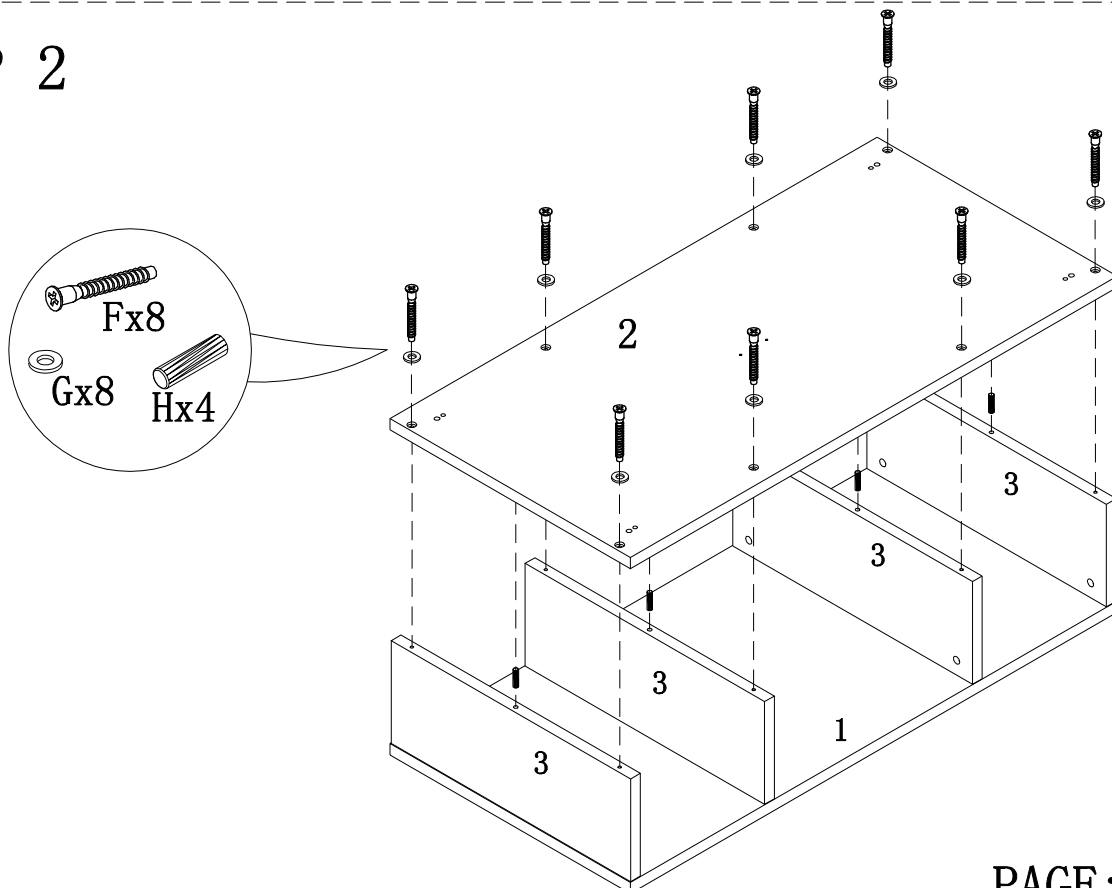

# ASSEMBLY INSTRUCTION

ITEM#: 151032CT

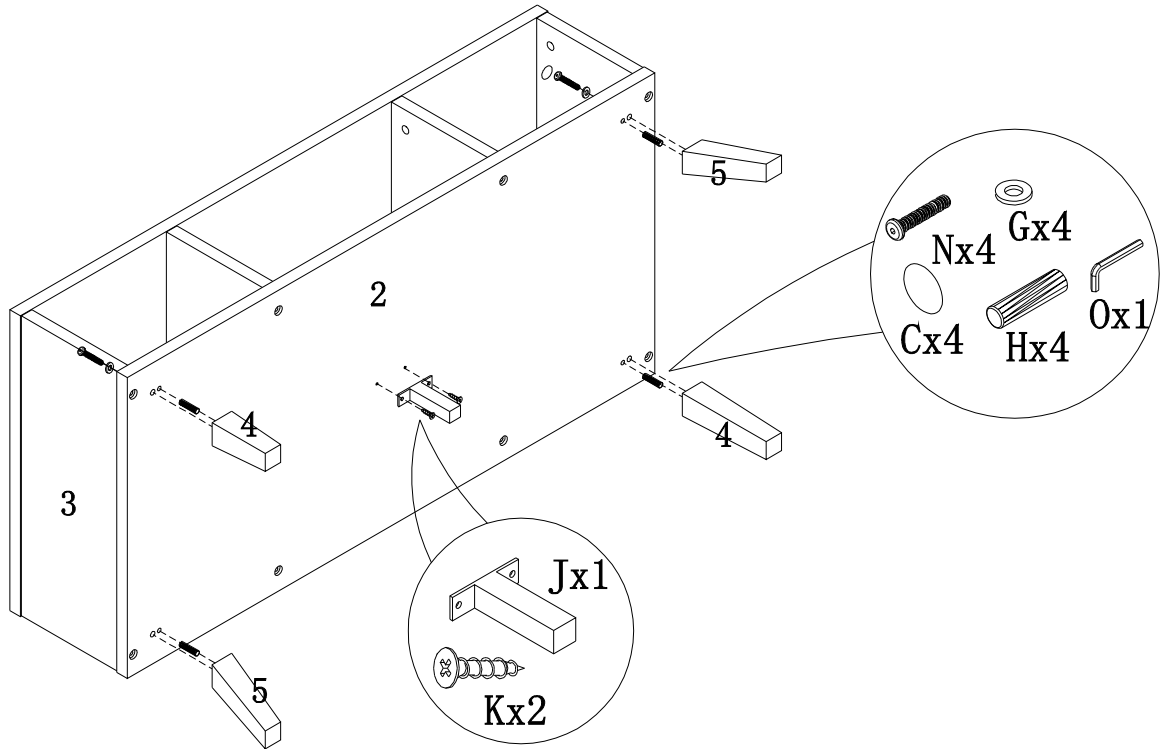

STEP 3

STEP 4

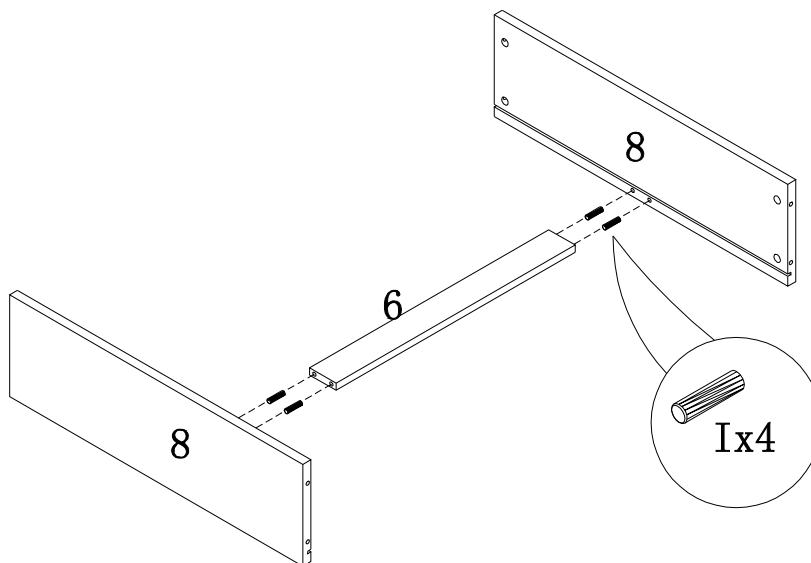

# ASSEMBLY INSTRUCTION

ITEM#: 151032CT

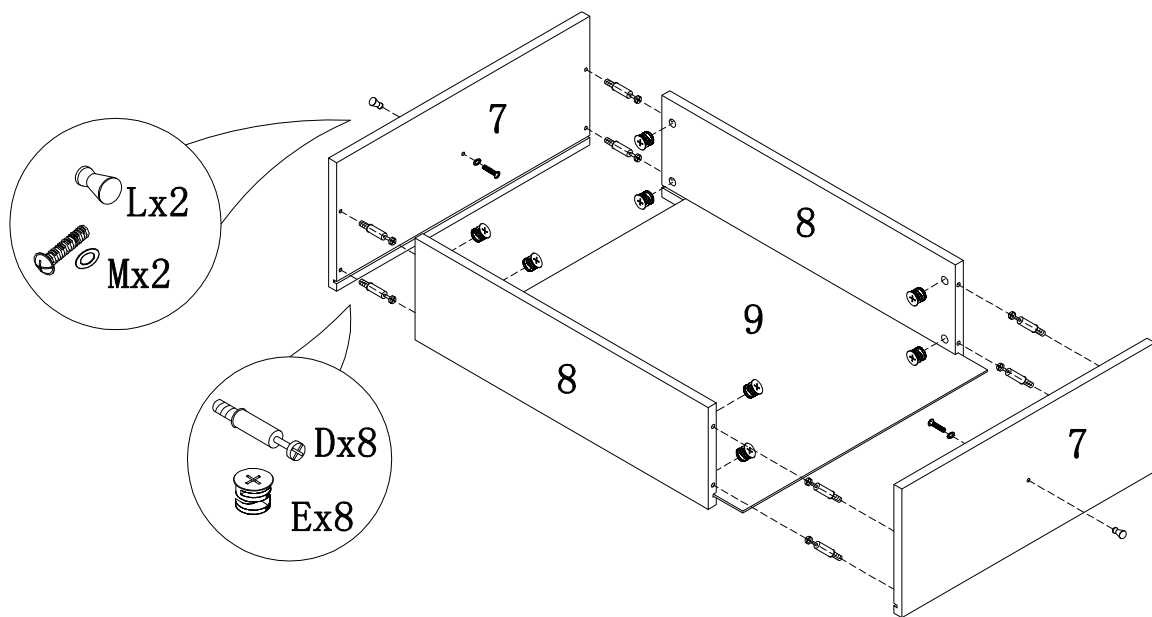

STEP 5

STEP 6

