

# ASSEMBLY INSTRUCTION

## **PLEASE READ BEFORE ASSEMBLING!**

Tip #1: Make sure you've taken all the pieces and hardware out of its packaging before discarding the box.

Tip #2: Using page 2 and/or page 3 of instruction manual make sure all pieces and hardware are accounted for.

Tip #3: Read manual before assembling, it helps!

ITEM#: 172219

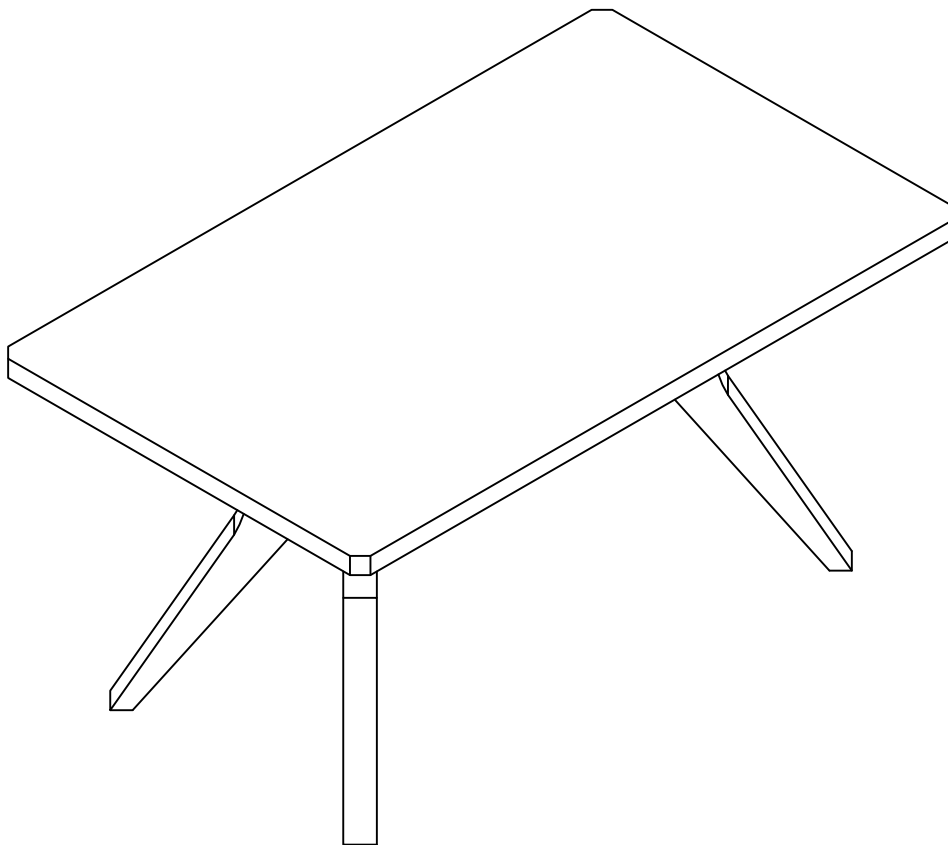

# PARTS IDENTIFICATION



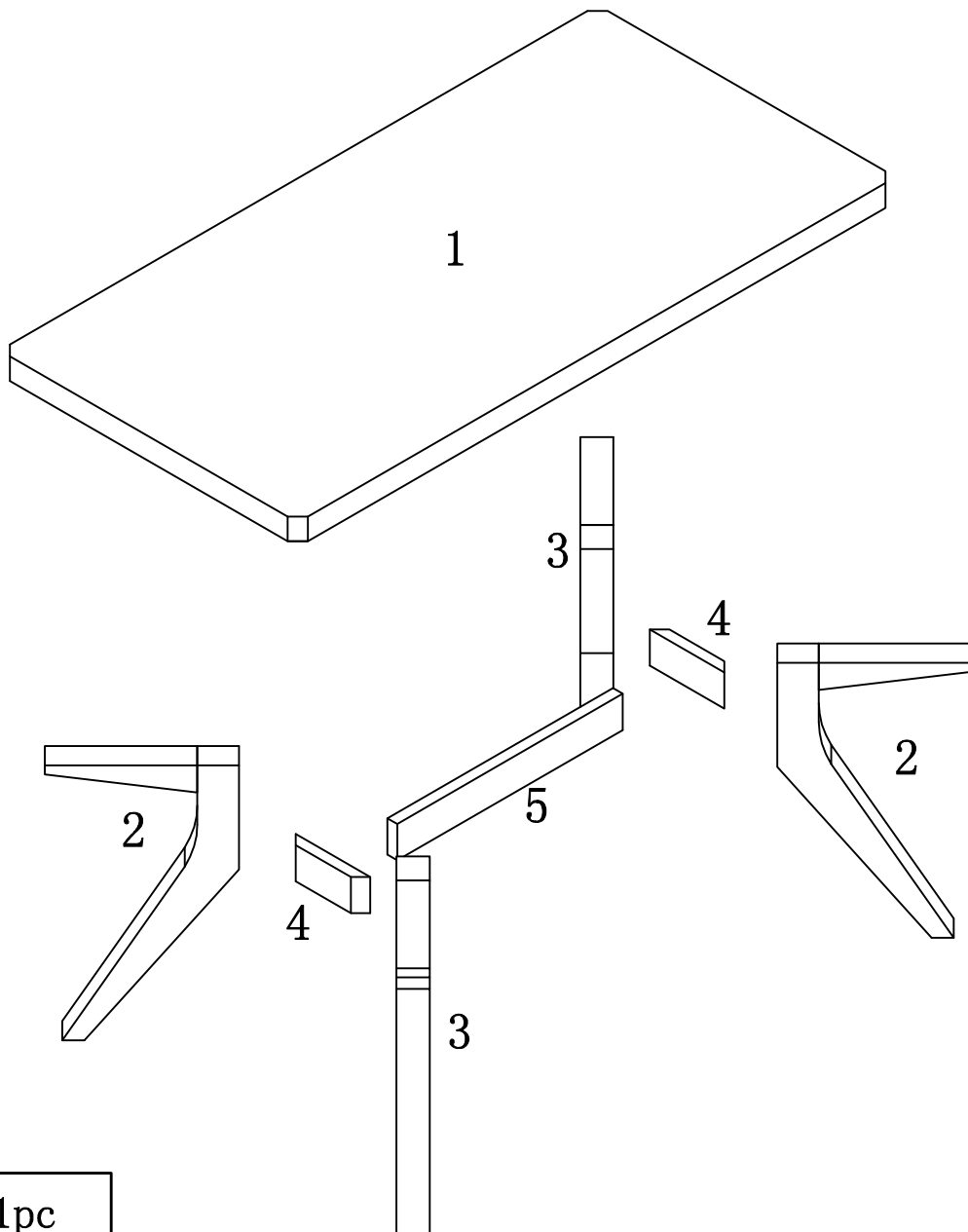







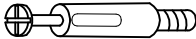



ITEM#: 172219



- |     |      |
|-----|------|
| (1) | 1pc  |
| (2) | 2pcs |
| (3) | 2pcs |
| (4) | 4pcs |
| (5) | 1pc  |

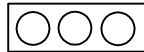

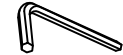
# HARDWARE IDENTIFICATION

ITEM#: 172219

A		L29	4pcs
B		φ 15	4pcs
C		φ 8 x 25	4pcs
D		φ 22	12pcs
E		φ 4 x 35	8pcs
F		M8 x 70	4pcs
G		M8	4pcs
H		M8	4pcs
I		φ 8 x φ 16 x 2	8pcs
J		M13	1pc
K		φ 45	4pcs
L		M8 x 35	4pcs
M		M5	1pc
N		φ 25x3	4pcs
O		Glue: For securing please apply to wood dowel first before inserting into panel	1pc

# ASSEMBLY INSTRUCTION

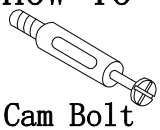
ITEM#: 172219

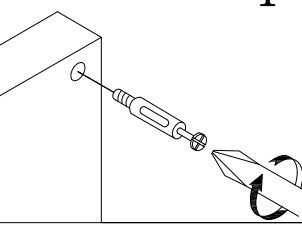
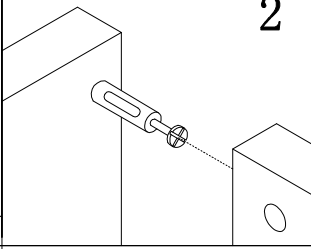
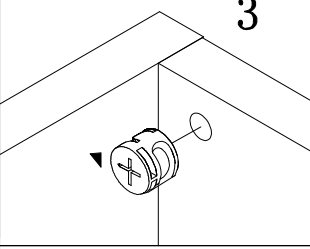
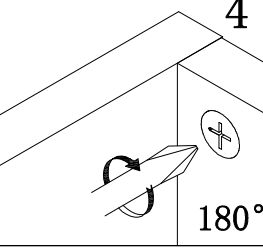
<b>HOW TO</b>  Cam Bolt  Cam Lock	<b>1</b> 	<b>2</b> 	<b>3</b> 	<b>4</b>  180°
	1. Screw Cam Bolt into panel.	2. Insert Cam Bolt into bolt hole of joining panel.	3. Insert Cam Lock. arrow facing bolt.	4. Gently turn Cam Lock clockwise to lock position.

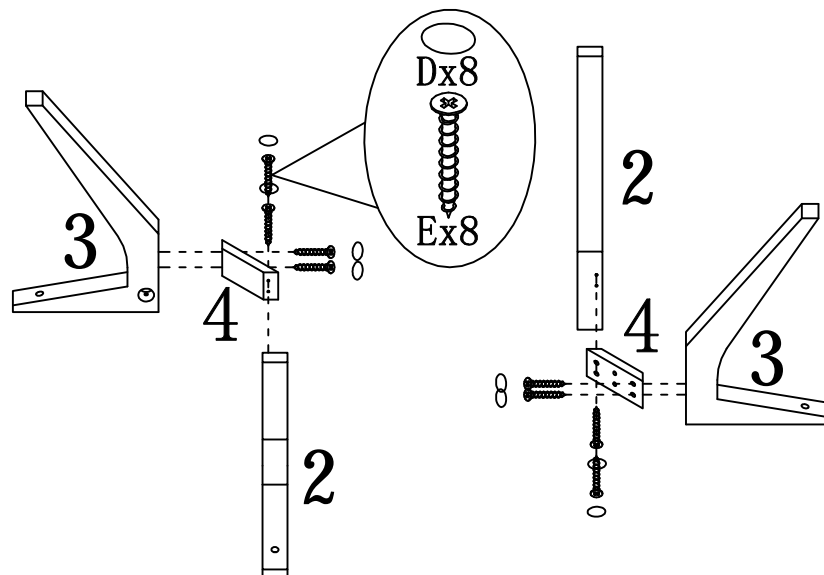

## STEP 2

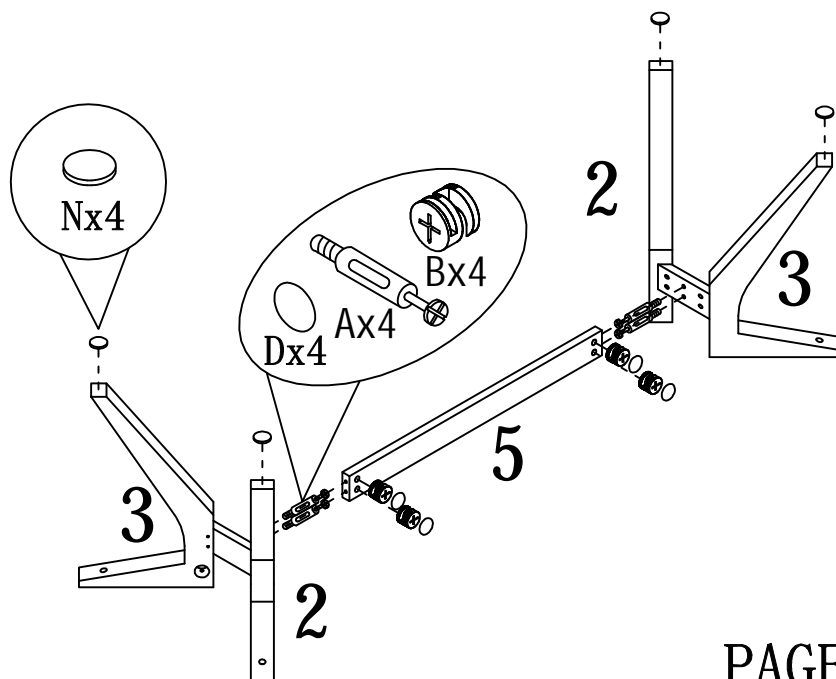

# ASSEMBLY INSTRUCTION

ITEM#: 172219

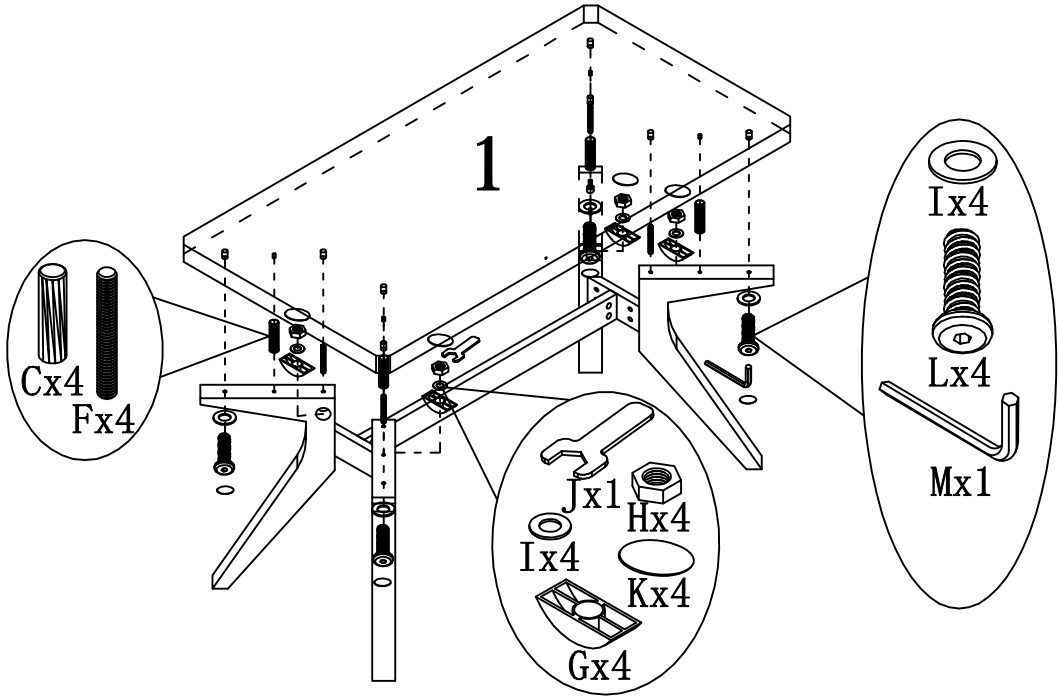

STEP3

STEP4

