

ASSEMBLY IDENTIFICATION

PLEASE READ BEFORE ASSEMBLING!

Tip #1: Make sure you've taken all the pieces and hardware out of its packaging before discarding the box.

Tip #2: Using page 2 and/or page 3 of instruction manual make sure all pieces and hardware are accounted for.

Tip #3: Read manual before assembling, it helps!

ITEM#: 26005

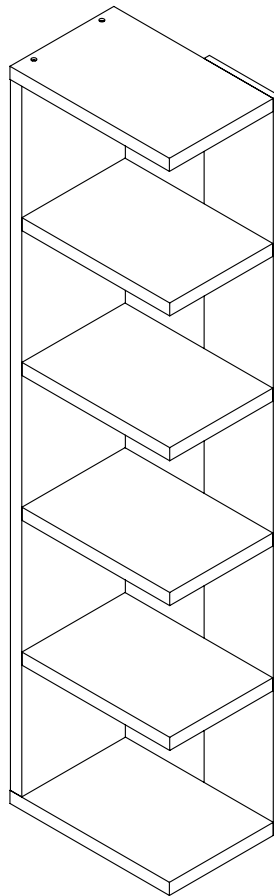

PARTS IDENTIFICATION



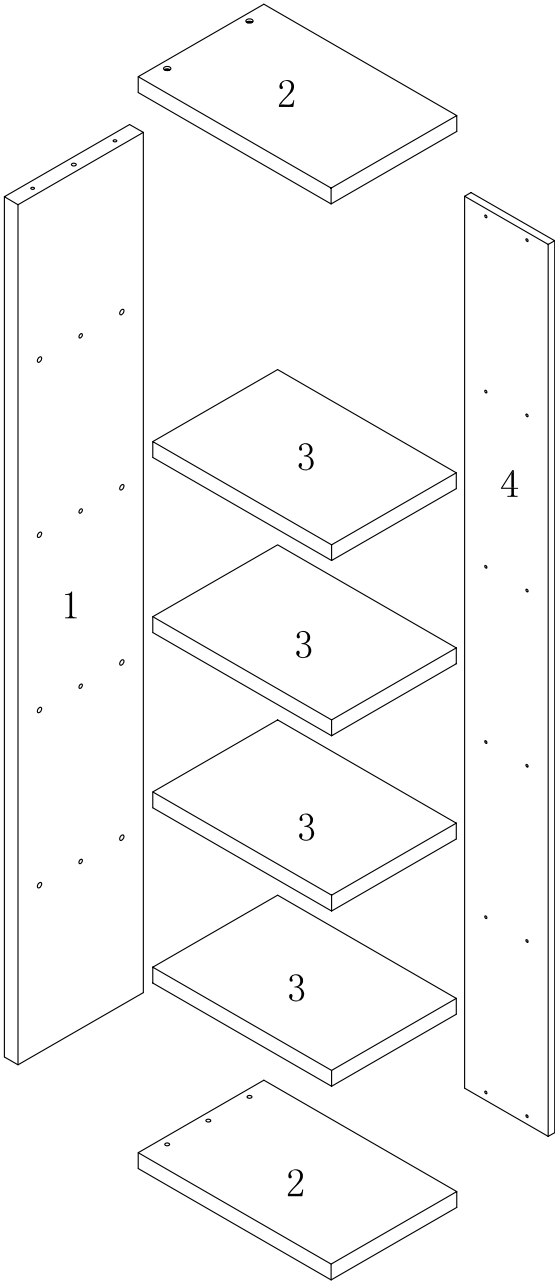

ITEM#: 26005

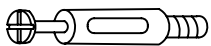

- (1) 1pc
- (2) 2pcs
- (3) 4pcs
- (4) 1pc

HARDWARE IDENTIFICATION

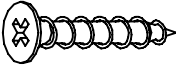
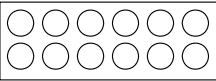
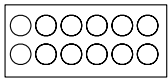
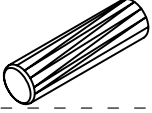
ITEM#: 26005

A		$\phi 7 \times 58$	4pcs
B		L29	8pcs
C		$\phi 15$	8pcs
D		$\phi 4 \times 30$	12pcs
E		$\phi 18$	12pcs
F		$\phi 13$	12pcs
G		$\phi 8 \times 25$	6pcs
H		It's used for stick the stopper to the connecting hole firmly	1pc

ASSEMBLY INSTRUCTION

ITEM#: 26005

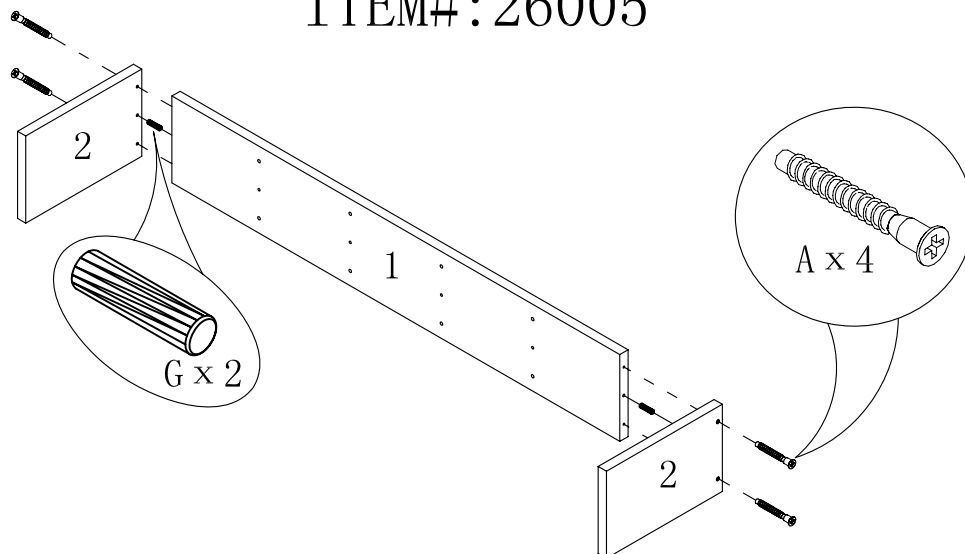

STEP1

PAGE: 3 OF 5

ASSEMBLY INSTRUCTION

ITEM#: 26005

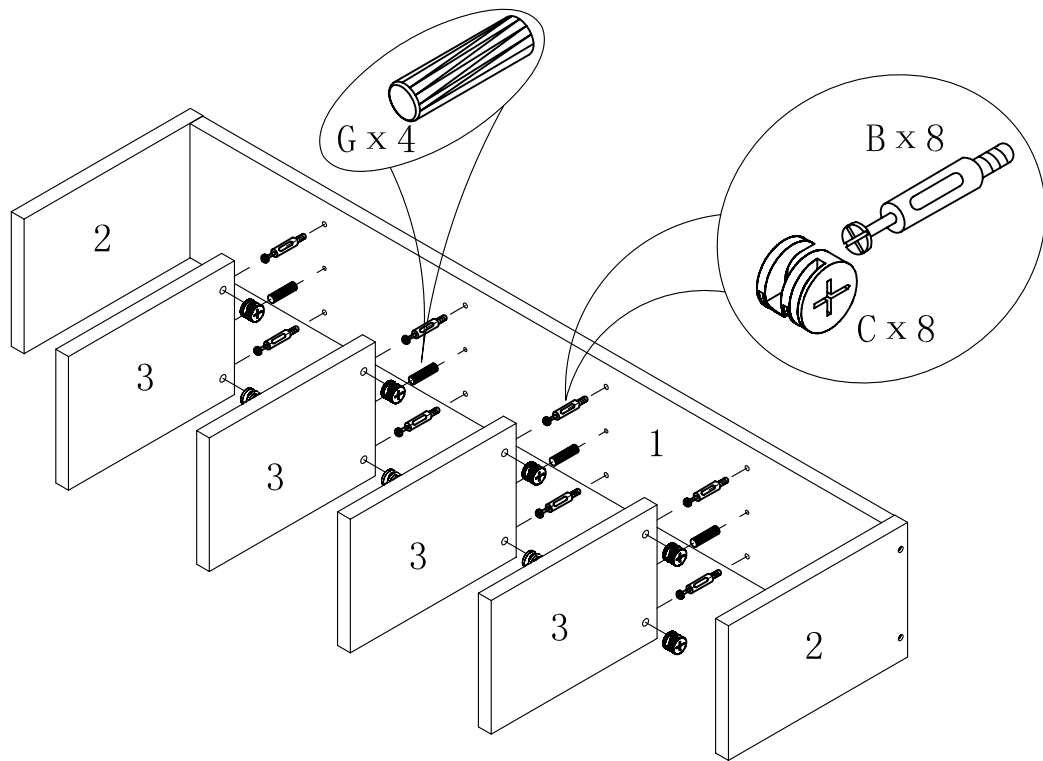

STEP 2

STEP 3

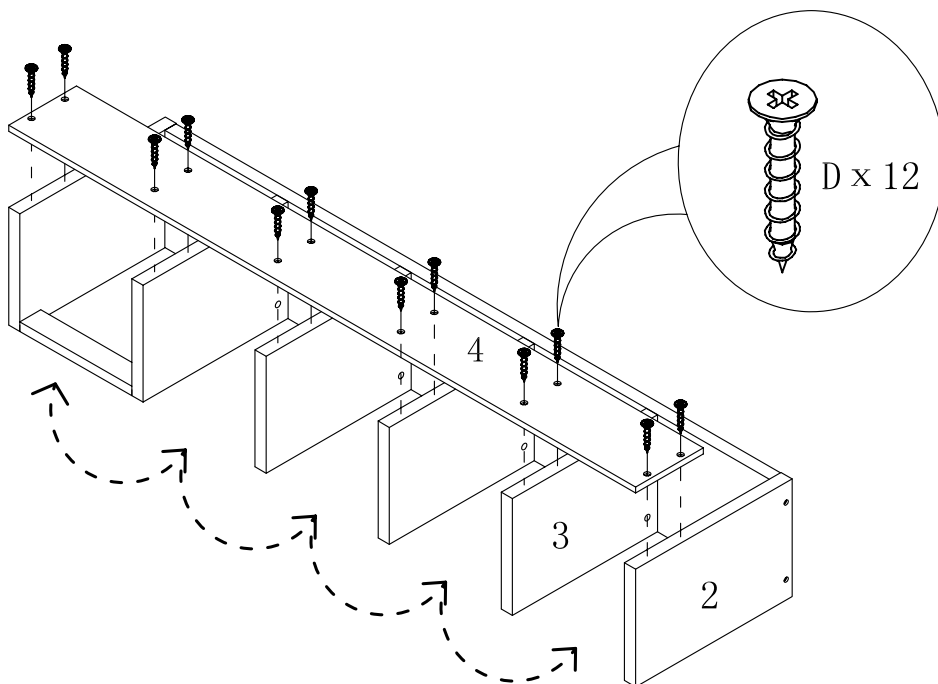

PAGE: 4 OF 5

ASSEMBLY INSTRUCTION

ITEM#: 26005

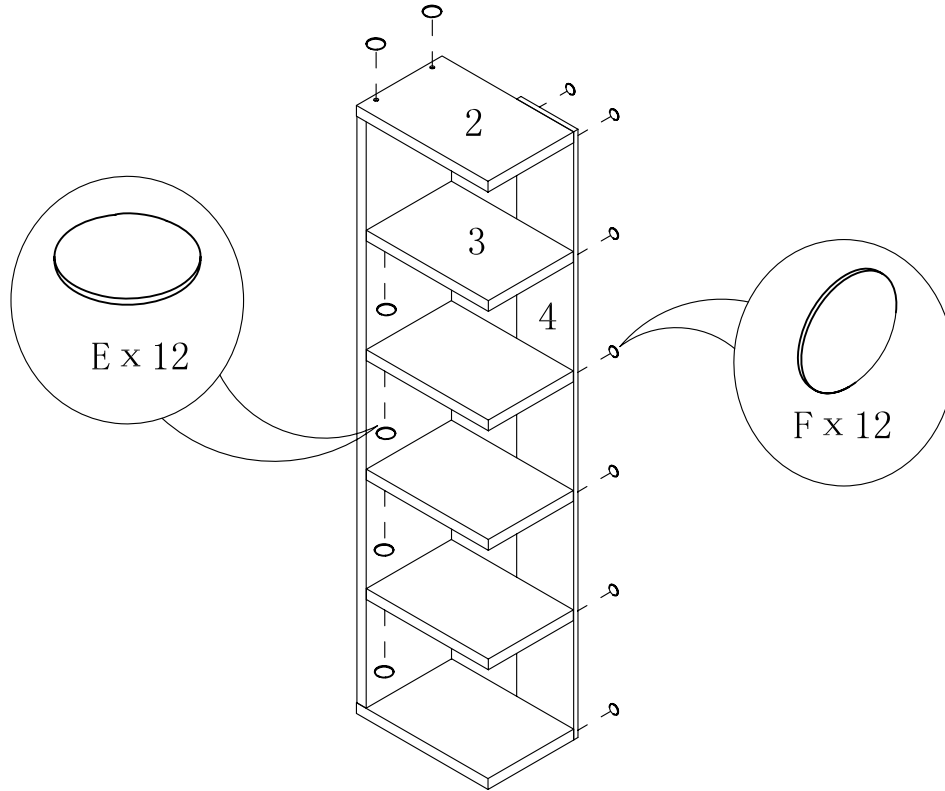

STEP4

STEP5

