

# ASSEMBLY INSTRUCTION

---

## **PLEASE READ BEFORE ASSEMBLING!**

Tip #1: Make sure you've taken all the pieces and hardware out of its packaging before discarding the box. Assembly on top of flattened box/blanket is recommended.

Tip #2: Using page 2 and/or page 3 of instruction manual make sure all pieces and hardware are accounted for.

Tip #3: Note position of all holes on each panel during assembly.

ITEM#: Y1101F Y1401F

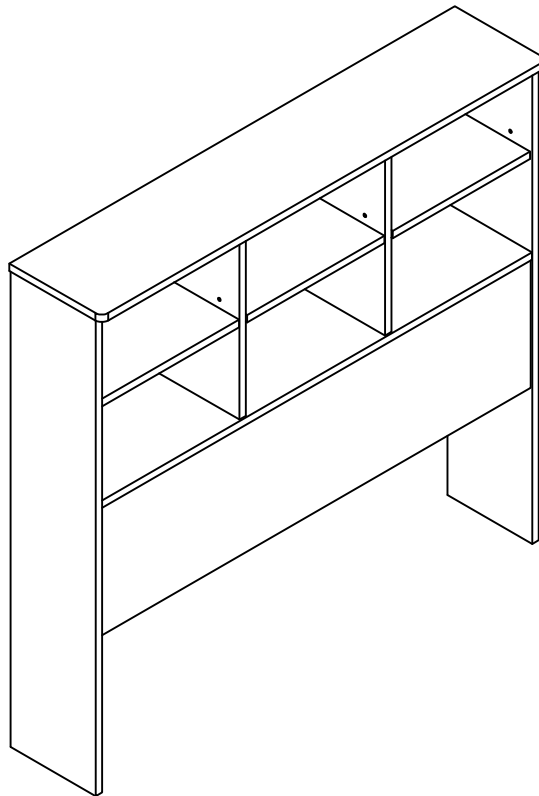

# PARTS IDENTIFICATION



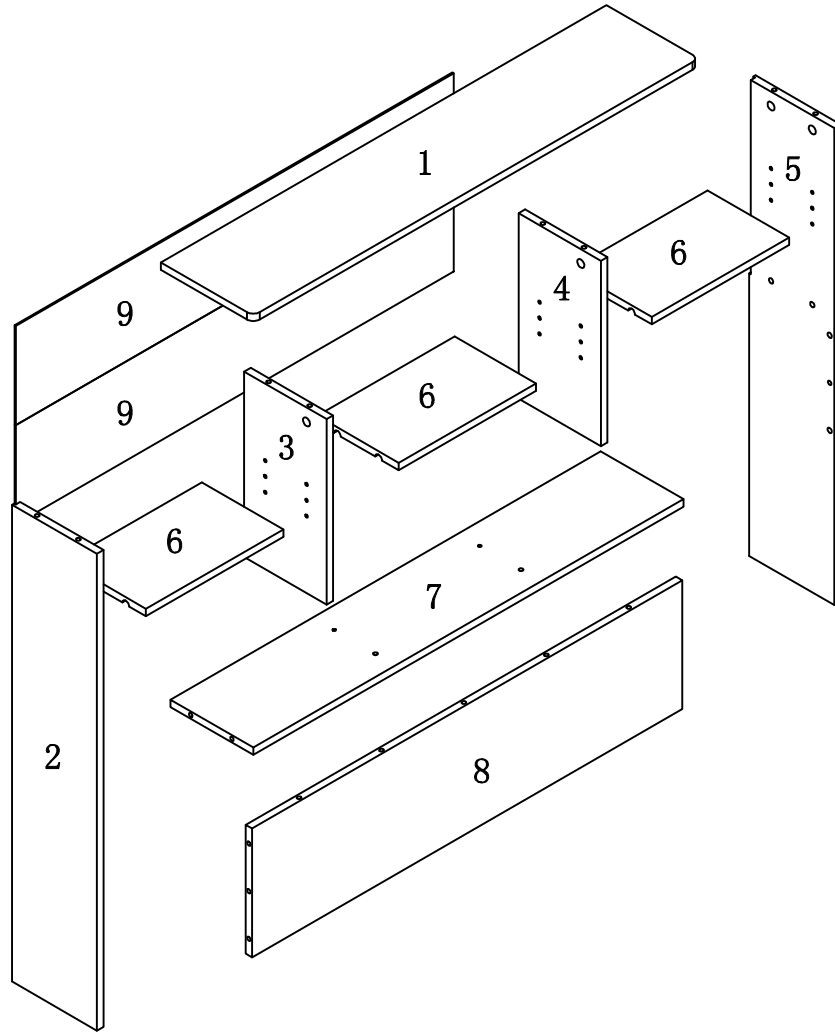



ITEM#: Y1101F Y1401F

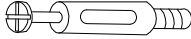

(1)	1pc	(6)	3pcs
(2)	1pc	(7)	1pc
(3)	1pc	(8)	1pc
(4)	1pc	(9)	2pcs
(5)	1pc		

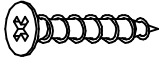
# HARDWARE IDENTIFICATION

ITEM#:Y1101F Y1401F

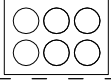
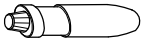
A		L29	16pcs
B		ø15	16pcs
C		ø4 x 35	2pcs
D		ø8 × 25	9pcs
E		ø5 × 15	12pcs
F		Z1016	36pcs
G		ø16	4pcs
H		ø20	6pcs
I		Glue: For securing please apply to wood dowel first before inserting into panel	1pc

# ASSEMBLY INSTRUCTION

ITEM#:Y1101F

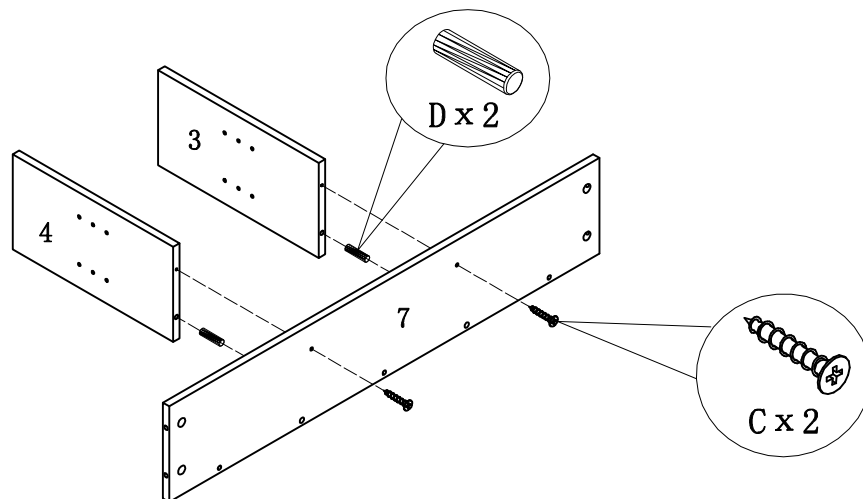

STEP1

PAGE 3 OF 6

# ASSEMBLY INSTRUCTION

ITEM#:Y1101F Y1401F

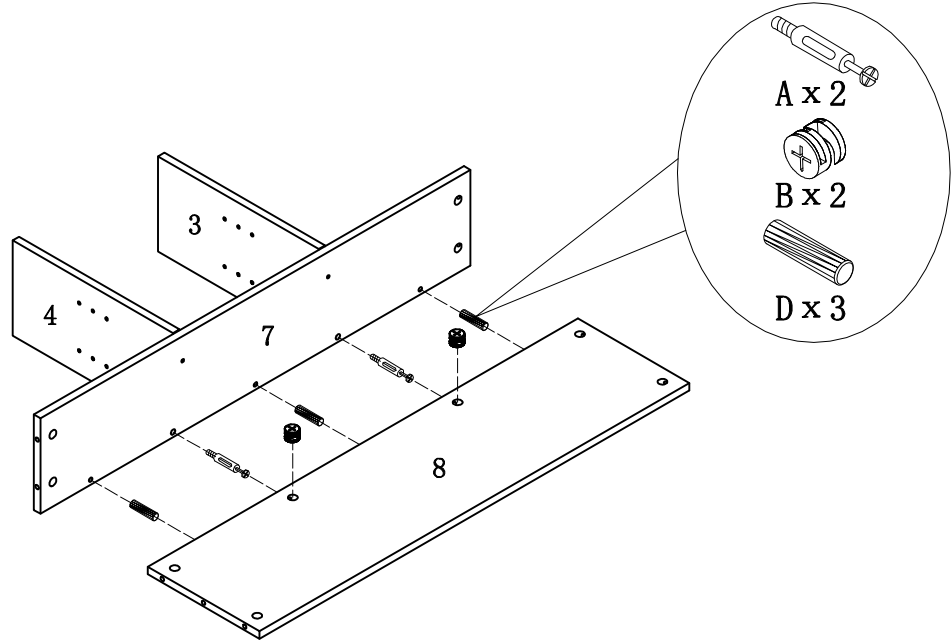

STEP2

STEP3

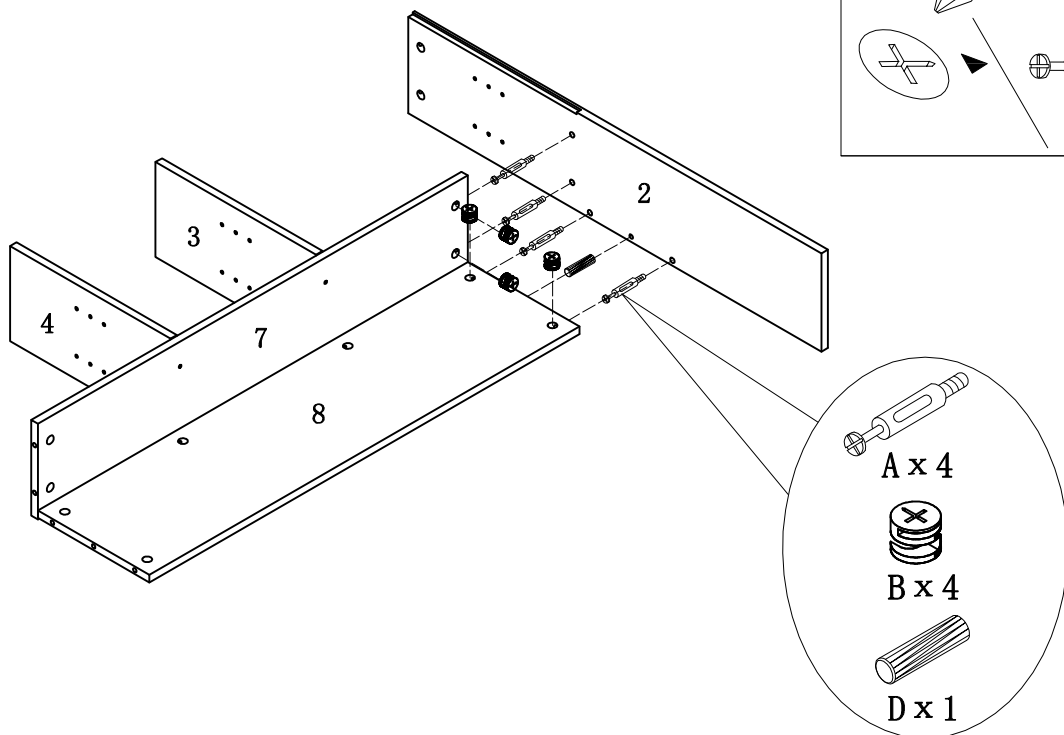

# ASSEMBLY INSTRUCTION

ITEM#:Y1101F Y1401F

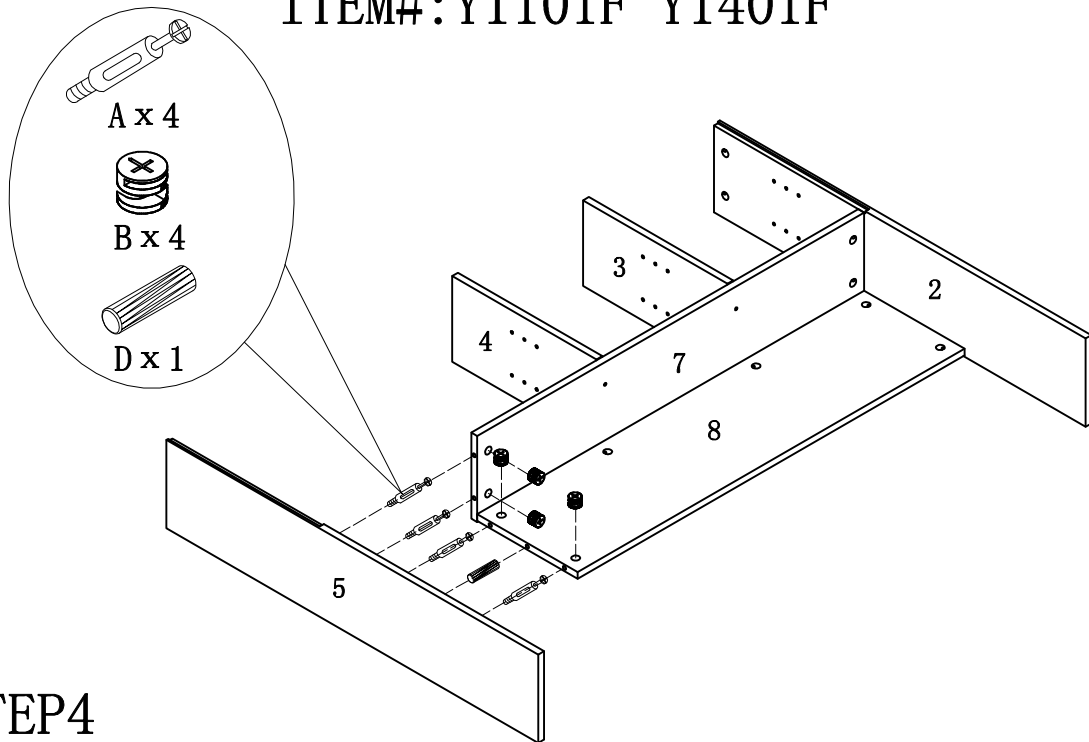

STEP4

STEP5

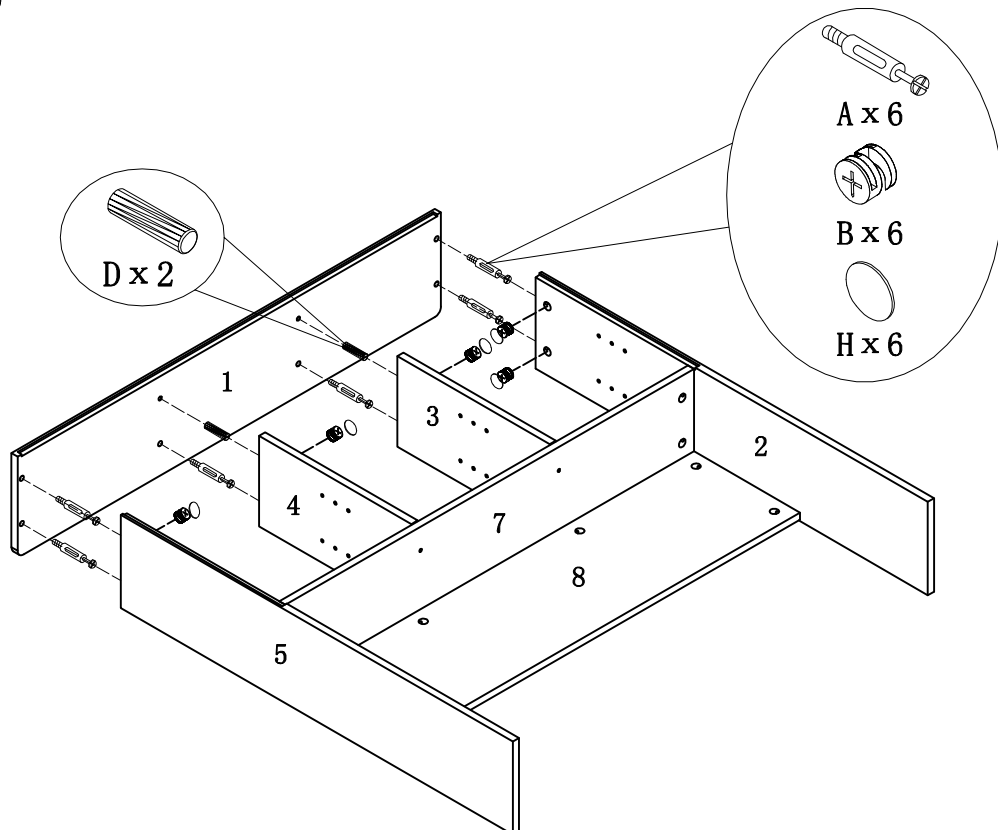

# ASSEMBLY INSTRUCTION

ITEM#:Y1101F Y1401F

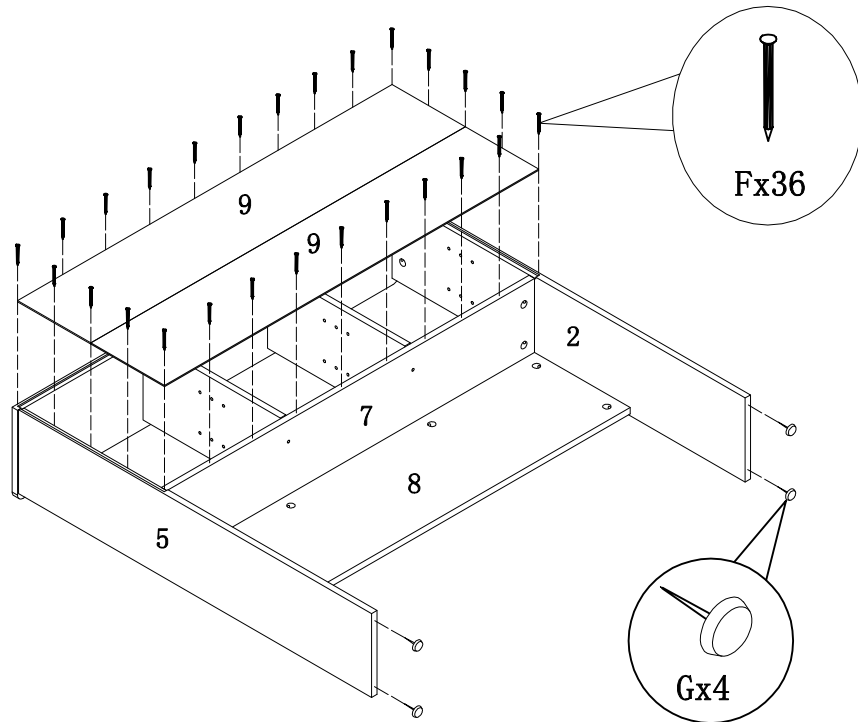

STEP6

STEP7

