

ASSEMBLY INSTRUCTION

ITEM# 111-5 222-5 555-5 14849 151198
 161526 161573 192506

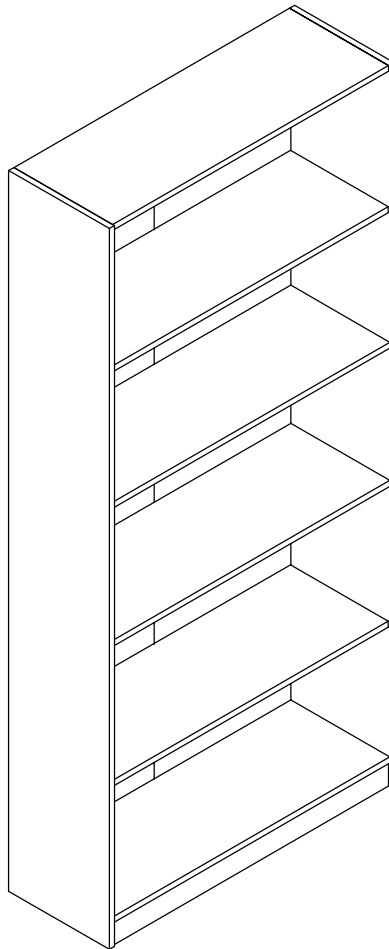

ASSEMBLY INSTRUCTION

PLEASE READ BEFORE ASSEMBLING!

Tip #1: Make sure you've taken all the pieces and hardware out of its packaging before discarding the box.

Tip #2: Using page 2 and/or page 3 of instruction manual make sure all pieces and hardware are accounted for.

Tip #3: Read manual before assembling, it helps!

ITEM#: 14849 151198 161526 161573

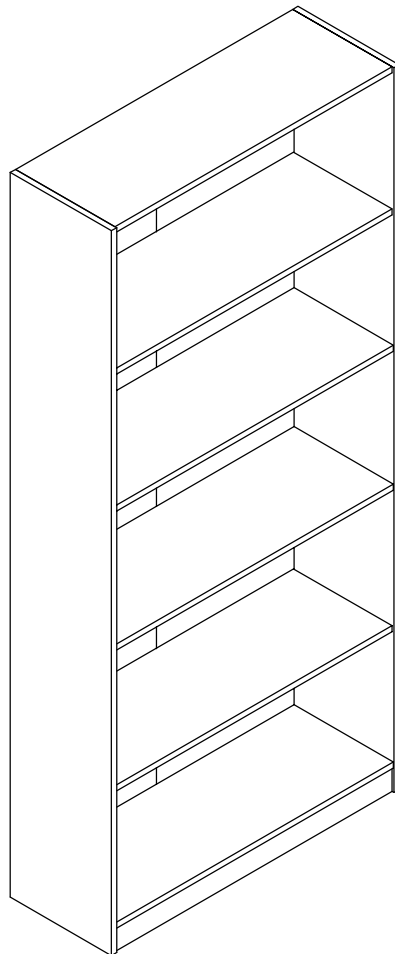

PARTS IDENTIFICATION



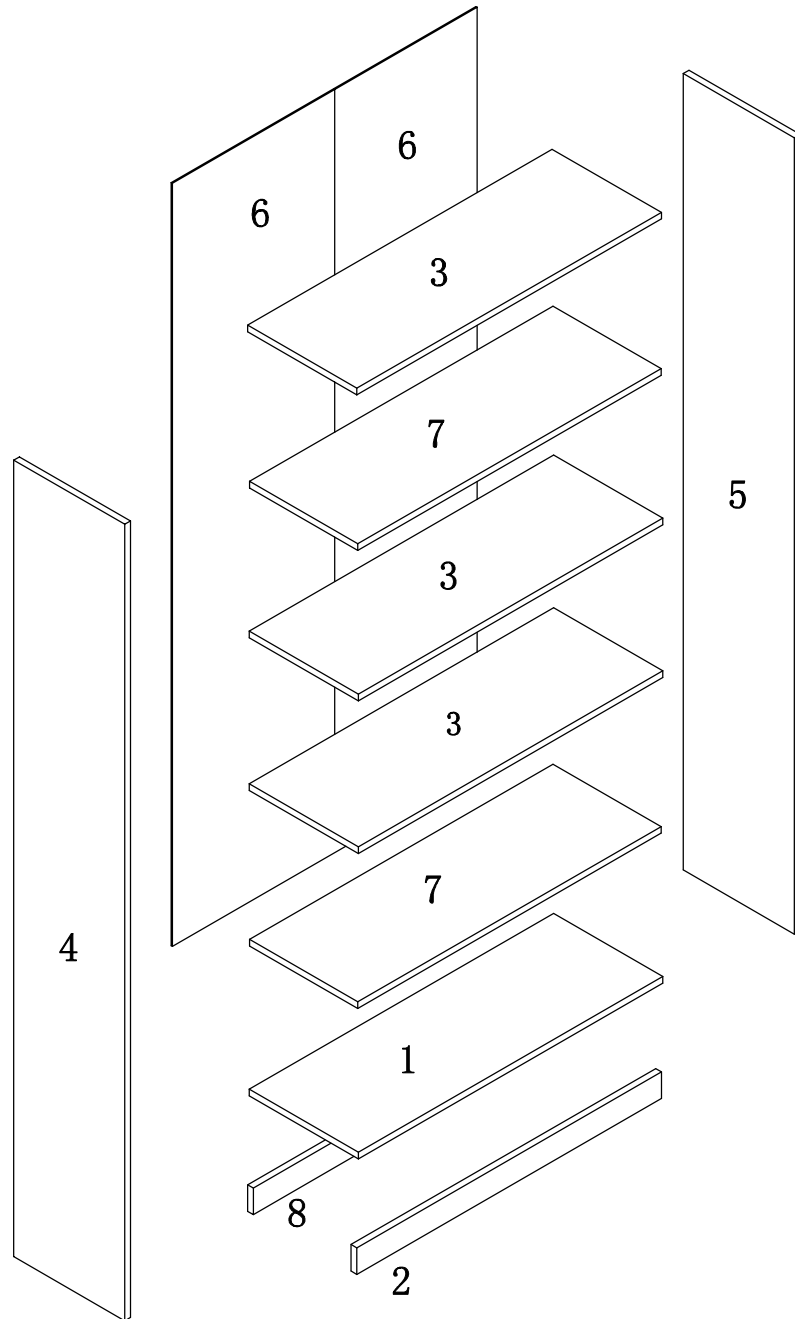





ITEM#: 14849 151198 161526 161573

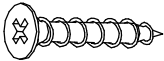

(1)	1pc	(5)	1pc
(2)	2pcs	(6)	2pcs
(3)	3pcs	(7)	1pc
(4)	1pc	(8)	1pc

HARDWARE IDENTIFICATION

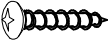
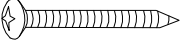
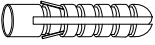
ITEM#: 14849 151198 161526 161573

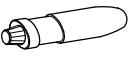
A		$\phi 4 \times 35$	16pcs
B			50pcs
C		$\phi 5$	8pcs
D		$\phi 8 \times 25$	18pcs
E		197 x 5 x 1	1pc
F		12 x 12 x 1	2pcs
G		$\phi 4 \times 25$	1pc
H		$\phi 5 \times 40$	1pc
I		$\phi 8 \times 40$	1pc
J		$\phi 16$	8pcs
K		Glue: For securing please apply to wood dowel first before inserting into panel	1pc

ASSEMBLY INSTRUCTION

ITEM#: 14849 151198 161526 161573

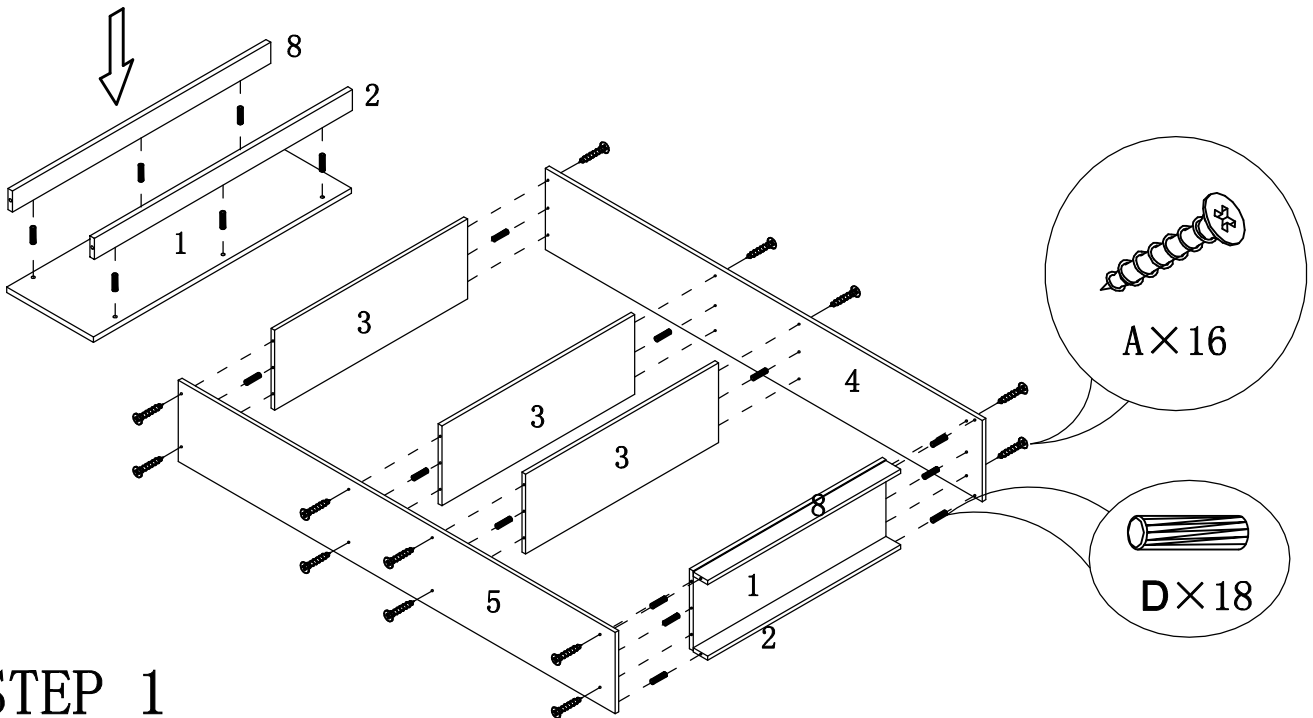

STEP 1

STEP 2

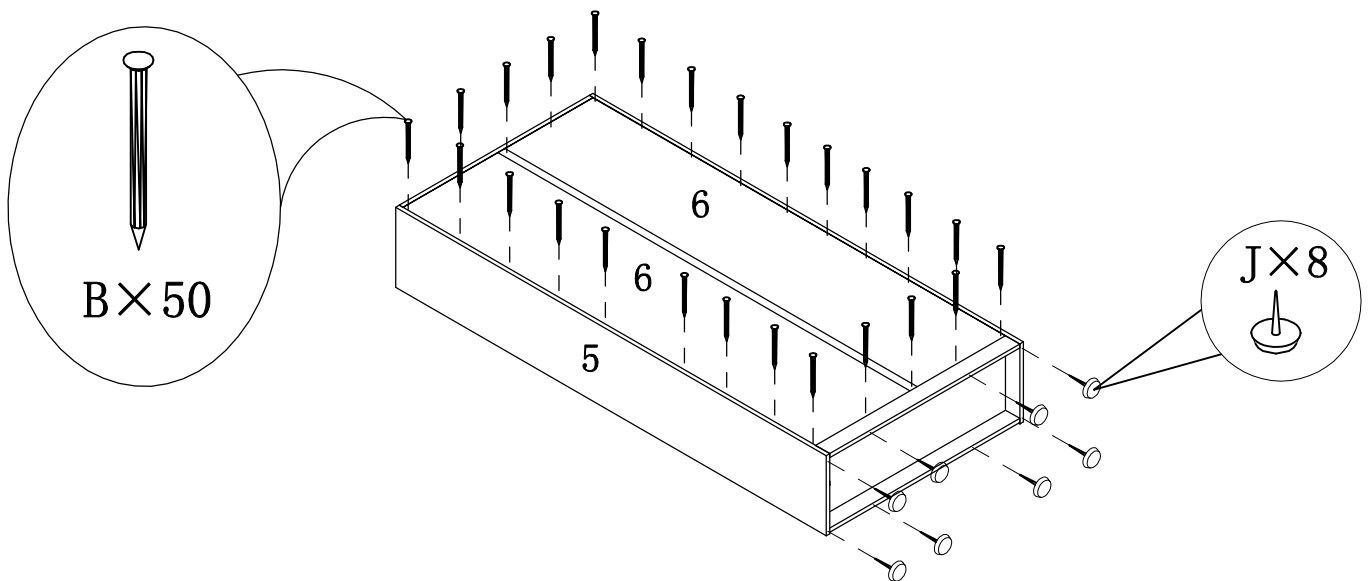

ASSEMBLY INSTRUCTION

ITEM#: 14849 151198 161526 161573

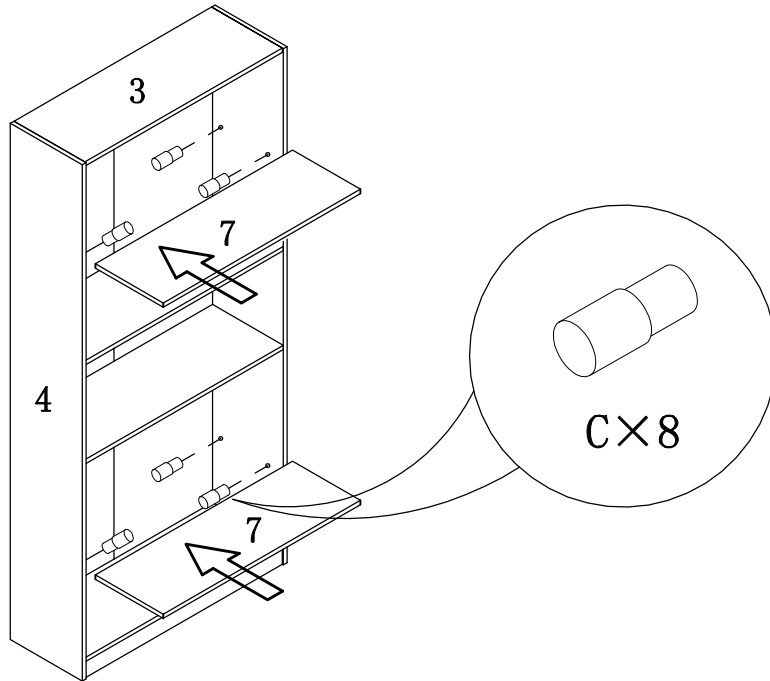

STEP 3

STEP 4

